

Turbo 400

ASPIRATORE DI FOGLIE
DEBRIS LOADERS
ASPIRATEUR DE FEUILLES
KRAFTVOLLE GRASS-UND LAUBSAUGER



Motore a scoppio a quattro tempi benzina verde mo. Honda
 Four stroke petrol engine mod. Honda
 Moteur 4 tps essence mod. Honda
 Viertaktmotor mod. Honda



Attacco a tre punti per trattore
 Mounted on tractor three points linkage
 Attelage trois points au tracteur
 Schlepper 3 - Pkt





Tubo con ruote per un facile utilizzo e raccolta
 Handled wheeled tube for easy collection with carrying belts
 Tuyau d'aspiration avec buse sur roulette et baudrier de soutien
 Handgeführtes Saugmaul mit Stützrad für einfachste Aufnahme
 mt Trageseil



Bocca in metallo leggero
 Light weight metal chute
 Tube léger en métal
 Kompakter Metallschlauch



Lama riduzione foglie.
 Leaves shred blade

-  L'aspiratore di foglie TURBO 400 è una macchina professionale di alta potenza. Usata da manutentori per pulire zone poco accessibili. Sono disponibili modelli da applicare alla sponda del camion o all'attacco a 3 punti del trattore, fornito a norme come standard europeo con tubo flessibile ø 200 mm e intercapedine sostituibile.
-  TURBO 400 is a powerful vacuum grass and leaves machine used from contractors to clean places where is not possible to enter with others equipment. This vacuum model can be placed on truck side or mounted on tractor 3 points linkage. The TURBO model is equipped with all safety norms as European standards, with replaceable inner wearing steel frame plates.
-  Le mod. TURBO 400 est un aspirateur de feuilles et herbe très puissant. Il permet l'aspiration dans les endroits qui ne peuvent être joints par d'autres système de nettoyage. Il existe la version pour application à la ridelle ou la version pour attelage 3 points au tracteur. Il est équipé avec les dispositifs de sécurité préconisés par les normes CEE, avec garnitures interchangeables de l'enveloppe turbine.
-  Der TURBO 400 ist der kraftvolle Gras- und Laubsauger zum Reinigen von Flächen. Diese Type kann seitlich an den Bordwänden von LKW's, Anhängern oder in der Schlepper 3-Pkt. eingesetzt werden und erfüllt alle europ. Sicherheitsnormen, mit auswechselbarer innerer Stahl-Schutzplatte.

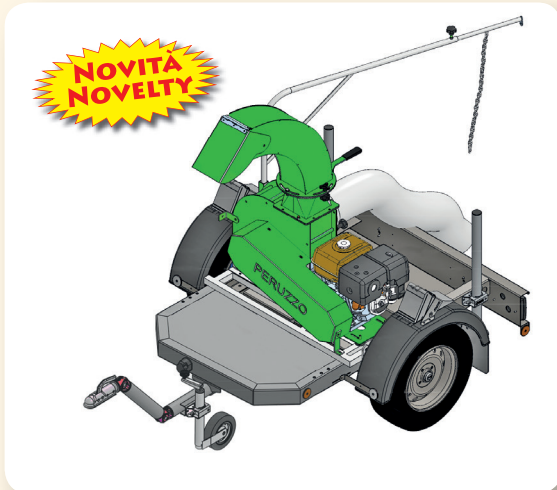

TURBO 400 su carrello stradale omologato
 TURBO 400 on approved road chassis
 TURBO 400 sur châssis routier approuvé
 TURBO 400 auf zugelassenem Straßenfahrgestell



Attacco traino
 Towing point
 Chappe d'attelage
 Gezogene Punkt

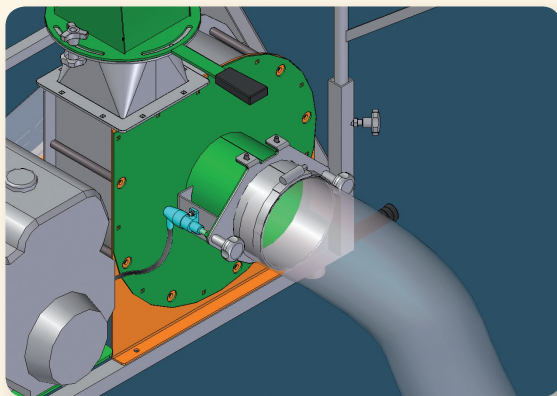





Dispositivo di sicurezza blocco motore
 Engine stop safety device
 Dispositif de sécurité de bloquage moteur
 Sicherheit Klemme für Motor



Ventola in HARDOX
 Fun HARDOX

Costruzione in acciaio HARDOX ad alta resistenza
 Frame and fan made in highh resistance HARDOX steel
 Construction en acier HARDOX haute resistance
 HARDOX Hohe Festigkeit Stahl

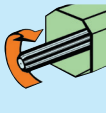
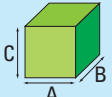
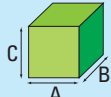
Modello Mod.				 Kg.	 m ³ /min							
							A	B	C	A	B	C
TURBO 400 B&S	40 cm - 15.7 inch	HP:13 - kW:9	4	170 - 374 lb	100/110		150	65	140	59	25	55
TURBO 400 HONDA	40 cm - 15.7 inch	HP:13 - kW:9	4	170 - 374 lb	100/110		150	65	140	59	25	55
TURBO 400 PTO	40 cm - 15.7 inch	HP:16-30 - kW:12-22	4	175 - 385 lb	100/110	540 rpm	110	77	150	43	30	59